

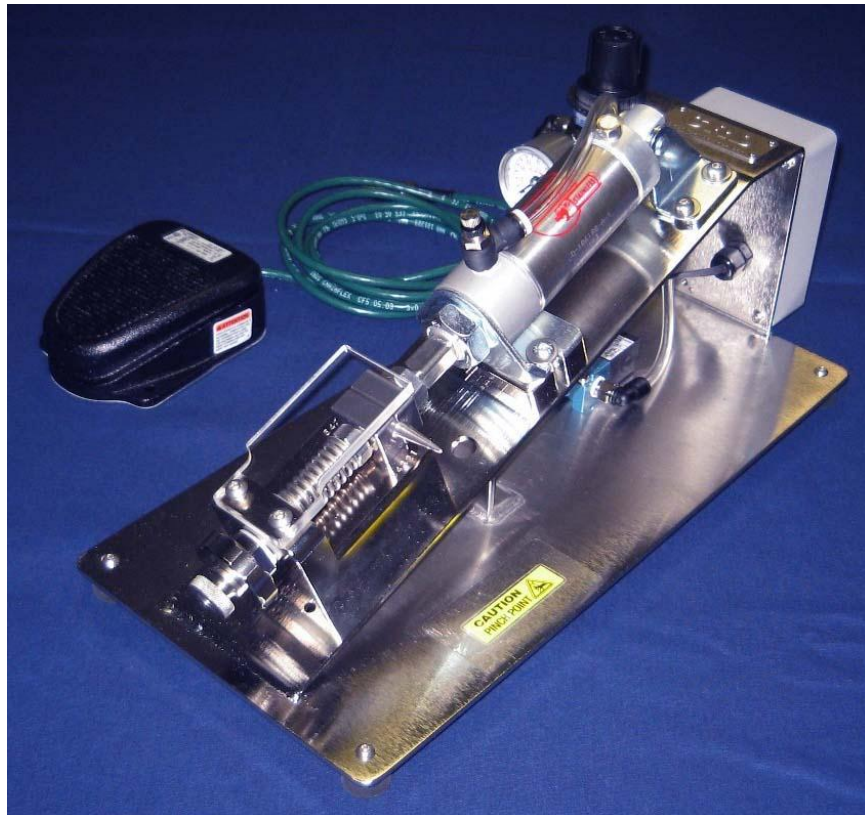

CLEAN ROOM DEVICES, LLC
"WHERE TUBING AND FITTINGS COME TOGETHER"

CRD201 TIME DELAY TUBING EXPANDER

OPERATIONS MANUAL



VERSION 1.1
LAST EDITED 03.08.11
DOCUMENT NUMBER 001

Table of Contents

| | |
|---|---|
| Title Page..... | 1 |
| Table of Contents..... | 2 |
| 1.0 General Product & Safety Information..... | 3 |
| 1.1 Product Information | |
| 1.2 Safety Information | |
| 2.0 Installation..... | 3 |
| 2.1 Air Supply | |
| 3.0 Operation..... | 4 |
| 3.1 Tube Expanding | |
| 4.0 Troubleshooting..... | 5 |
| 5.0 Maintenance..... | 6 |
| 5.1 Periodic Cleaning (annually) | |
| 6.0 Product Specifications..... | 6 |
| 7.0 Durometer Scale..... | 6 |
| 8.0 Parts List..... | 7 |
| 9.0 Warranty..... | 8 |
| 9.1 Warranty | |
| 9.2 Warranty period | |

1.0 General Product & Safety Information

1.1 Product Information

- Unit is designed to expand flexible tubing up to a durometer of Shore A 85 (Shore D 35), including any non-metallic braided materials
- The minimum/maximum inside tube diameter is 1/16" – 9/16"
- The expander jaws are universal in design to meet most applications
- The unit design allows for simple operator adjustment

1.2 Safety Information

- This product uses an air cylinder and foot pedal to pneumatically actuate the expanding jaws. The unit is not intended to expand anything other than flexible tubing.

WARNING

Avoid placing your fingers between the upper jaw block and the air cylinder mounting bracket while operating unit, sufficient pressure exists to cause personal injury.

- The desired air supply should be free of moisture/contaminates, and set to 80-100 psi. It is recommended that a suitable filter/regulator be installed onto the supply line prior to the unit to preserve the life expectancy of the air components.

2.0 Installation

Ensure all five (5) rubber feet are completely stabilized on your work surface prior to applying air pressure to the unit.

2.1 Air Supply

- Connect a 1/4" air supply hose to the fitting found on the regulator. The air supply should be free of moisture and contaminants. Standard facility compressed air within the range of 80-100 psi is recommended. Lower than 80 psi may affect the unit's ability to expand properly with even pressure. Higher than 100 psi may reduce the life expectancy of working parts.

2.2 Electrical

- 120 to 240V AC power supply required for operation. The unit will come with the appropriate power supply.

3.0 Operation

3.1 Jaw Adjustment

- Start by loosening the knurled *thumb-nut* to adjust the unit for the proper tubing size.
- Locate the lower expander jaw position for your tubing size using the larger *thumb-wheel* and engraved scale.

(This adjustment may require fine tuning depending on your tubing I.D., O.D., Durometer or material. It is recommended you note or log scale settings for future applications, or usage.)

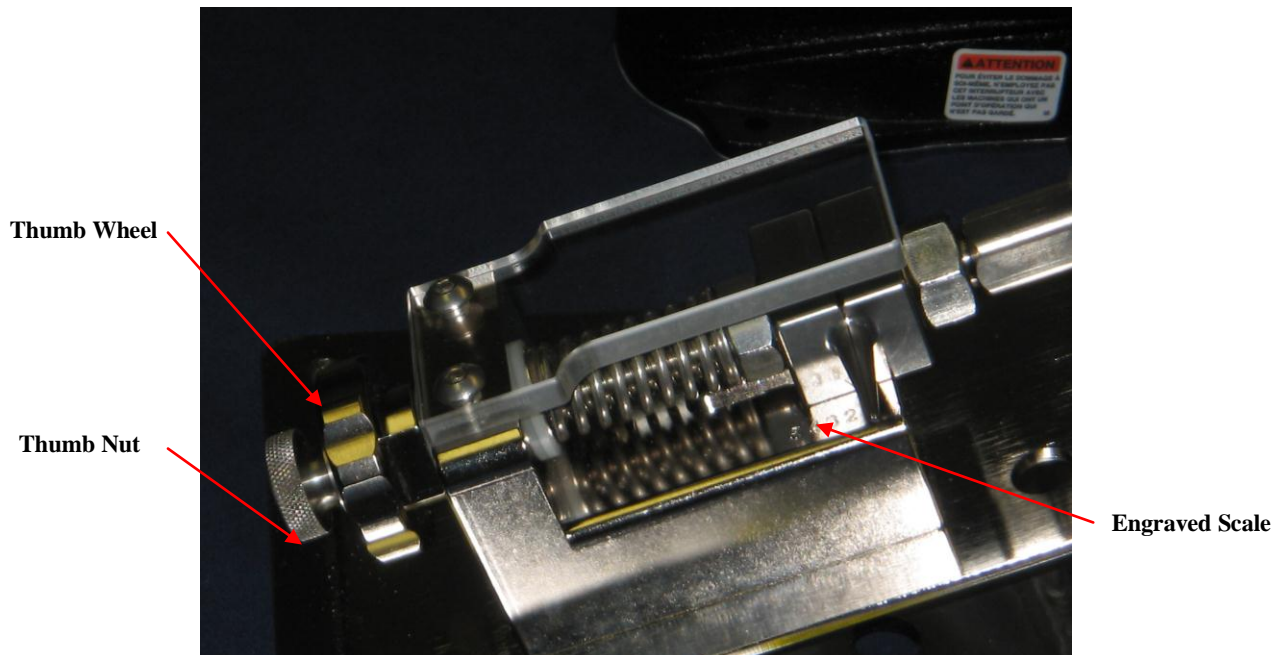

Figure 1: Jaw Adjustment

- Next, tighten the *thumb-wheel* against the lower mounting block and secure in place using the *thumb-nut*.

3.2 Connection setup

Setting up the connections on the CRD201 is a simple task. Please reference figure 2 below when making all connections to the back panel:

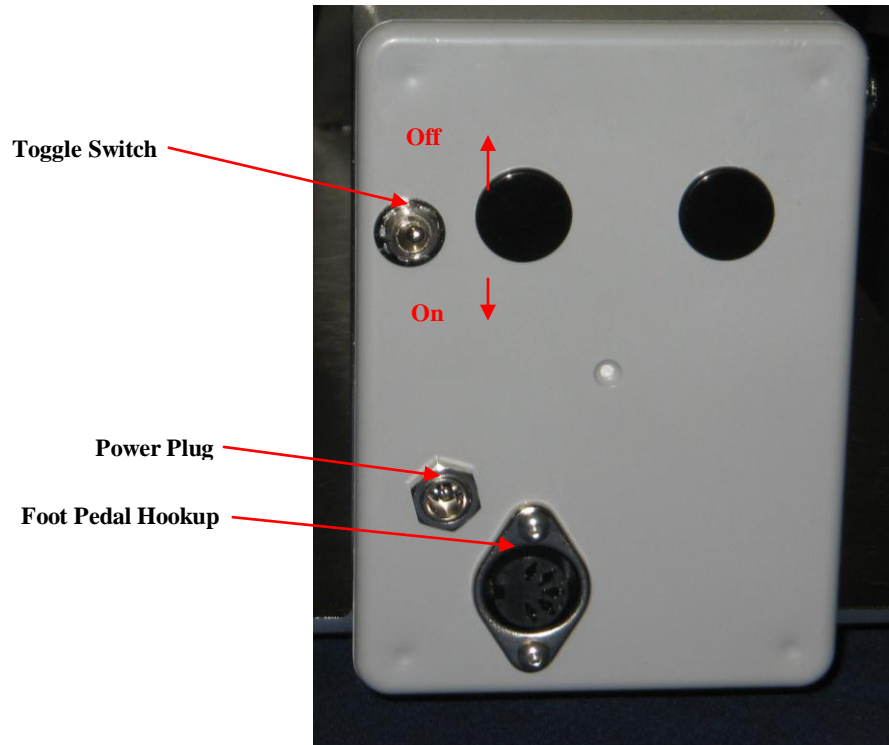

Figure 2: Back Panel Hookup

3.3 Setting the Time Delays

- The CRD201 expansion operation is designed to let the operator expand each piece of tubing twice. After the first expansion, the jaws will close and the operator rotates the tube 90 degrees and the jaws will automatically expand again using the sensor. This ensures that the tubing is expanded in a uniform fashion, and not deformed in only one direction. To assist with this 2-step expansion operation, there are 2 time delay relays on the unit.
 - **Expansion Time** – This setting adjusts the rate (0.5-25.0 seconds) at which the tube expansion occurs. The rate at which the tube is expanded is critical to prevent tearing. Some stiffer tubing might need a longer expansion time, while softer tubing can be expanded rapidly.
 - **Interval Time** – This setting adjusts the time delay rate (0.5-5.0 seconds) at which the jaws will cycle. It is adjusted to allow the operator to rotate the tubing 90 degrees at a comfortable pace between expanding.

- Remove the hole plugs with a screwdriver on the rear cover to gain access to the Time Delay adjustment pots



Figure 3: Removing access hole plugs

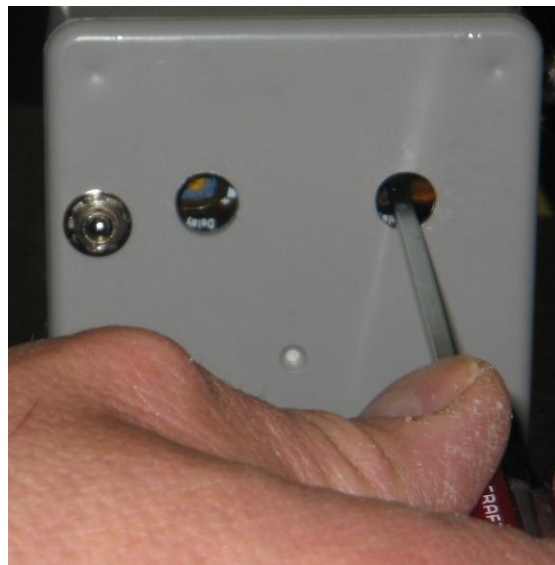

Figure 4: Adjusting the Expansion Time pot

- Using a small Phillips drive screwdriver adjust the Time Delay relays

- Figure 5 below shows the CRD201 with the rear cover removed, as well as the location of both time delay adjustments on the time delay relay:



Figure 5: Time Delay Relay and Time Adjustment Pots

3.4 Expanding Operation

- Place the desired tubing over expander jaws at the required depth.
- Once the tube is placed over the jaw, the jaws can be activated using the foot pedal. The jaws will expand at the rate determined by the expansion time setting.
- The jaws will then close and the operator will remove the tubing.
or
- If the foot pedal is held down, the jaws will open for the set time and then close for the set time at which the operator will rotate the tubing 90 degrees.
***Failure to do so may result in uneven expansion and/or damaged tubing!**
- The jaws will then close and the operator will remove the tubing.

4.0 Troubleshooting

| Operating Error | Action |
|---------------------------------------|---|
| Unit does not operate. | <ol style="list-style-type: none">1. Check the facility air connection.2. Check all air hose connections on the unit. |
| Jaws do not expand. | <ol style="list-style-type: none">1. Ensure there are no obstructions keeping the jaws from expanding.2. Completely depress the foot pedal to actuate.3. Ensure the toggle switch is set to the on setting. |
| Flexible tubing is splitting/tearing. | <ol style="list-style-type: none">1. Ensure the tubing being expanded does not exceed the recommended durometer.2. Ensure the lower jaw has been adjusted correctly for the tubing inside diameter (I.D.).3. Verify facility air supply psi or unit pressure adjustment.4. Increase the expansion time setting for a more gradual expansion. |
| | |

5.0 Maintenance

5.1 Periodic Cleaning (annually)

- Wipe down outer surfaces with alcohol, septihol or mild detergents as required.

6.0 Product Specifications

| | |
|---------------------|--|
| Unit Weight | 8 LBS / 3.5 KG |
| Overall Dimensions | 15 in. (38cm) lg. x 7 in. (18cm) w. x 7 in. (18cm) ht. |
| Minimum/Maximum PSI | 80 PSI / 100 PSI |
| | |

7.0 Durometer Scale

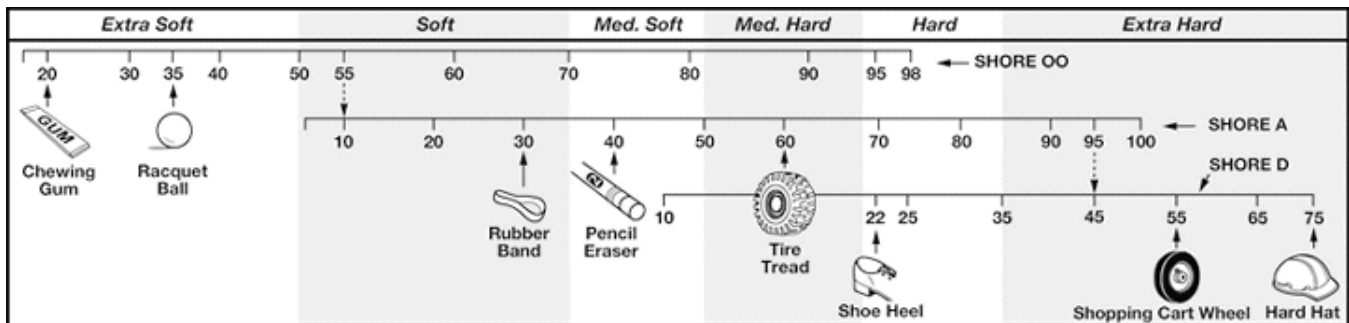

8.0 Parts List

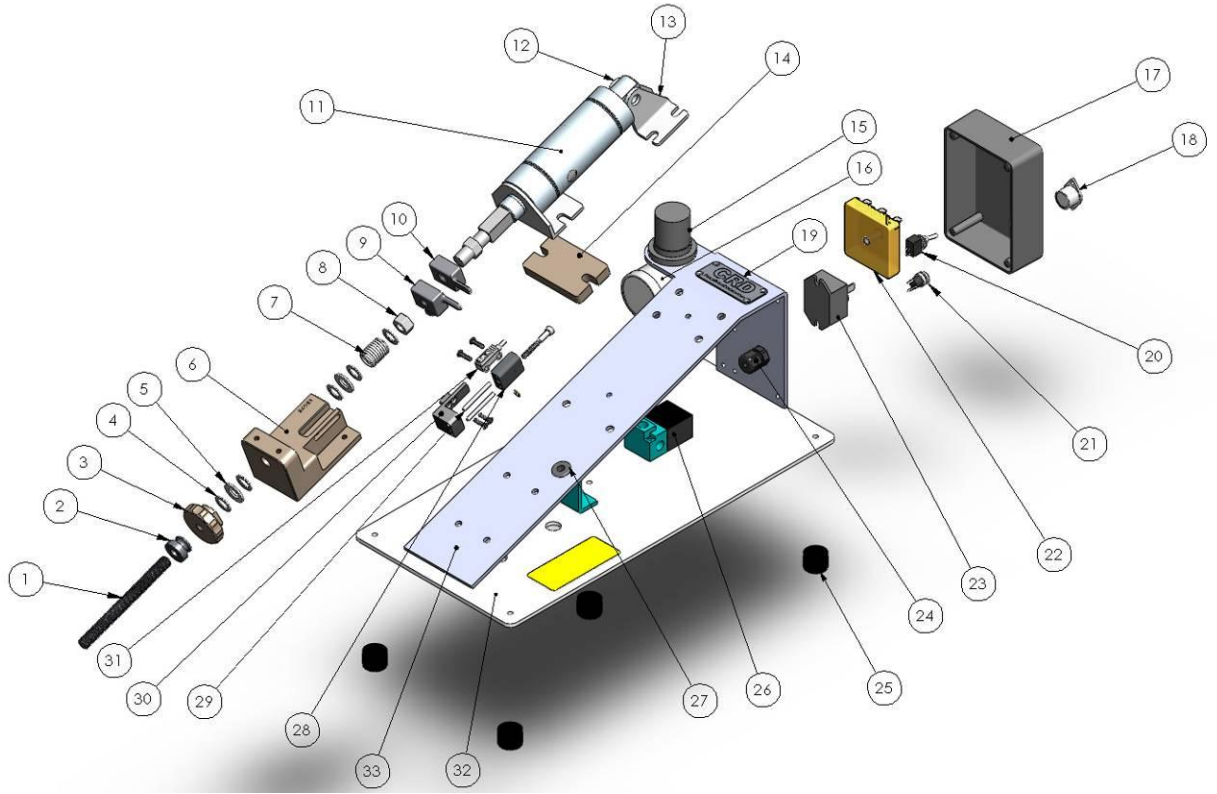

| ITEM NO. | PART NUMBER | DESCRIPTION | QTY. |
|----------|-------------|---------------------------|------|
| 1 | P00057 | ROD, THREADED | 1 |
| 2 | P00060 | THUMB NUT | 1 |
| 3 | CD002-010 | THUMB WHEEL | 1 |
| 4 | P00056 | WASHER, FLAT | 5 |
| 5 | P00086 | WASHER, NYLON | 2 |
| 6 | CD202-004 | BLOCK, MOUNTING, LOWER | 1 |
| 7 | P00055 | SPRING, COMPRESSED | 1 |
| 8 | P00085 | NUT, HEX | 2 |
| 9 | CD002-022 | JAW, EXPANDER, LOWER | 1 |
| 10 | CD002-021 | JAW, EXPANDER, UPPER | 1 |
| 11 | P00054 | AIR CYLINDER | 1 |
| 12 | P00027 | BRACKET, MTG, REAR, LEFT | 1 |
| 13 | P00027 | BRACKET, MTG, REAR, RIGHT | 1 |
| 14 | CD002-018 | PLATE, SPACER | 1 |
| 15 | P00066 | REGULATOR, AIR | 1 |
| 16 | P00280 | GAUGE, AIR | 1 |
| 17 | P00275 | COVER, REAR | 1 |
| 18 | P00328 | PLUG, FOOTPEDAL | 1 |
| 19 | CD001-027 | NAME PLATE | 1 |
| 20 | P00079 | SWITCH, TOGGLE | 1 |
| 21 | P00119 | JACK, POWER | 1 |
| 22 | P00264 | RELAY, TIME DELAY | 1 |
| 23 | P00265 | RELAY SWITCH | 1 |
| 24 | P00094 | STRAIN RELIEF | 1 |
| 25 | P00026 | FOOT, RUBBER | 5 |
| 26 | P00108 | VALVE, SOLENOID, 3-WAY | 1 |
| 27 | P00329 | GROMMET | 1 |
| 28 | CD002-002 | BASE PLATE | 1 |
| 29 | CD002-002 | TOP PLATE | 1 |

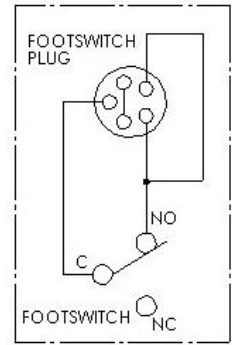
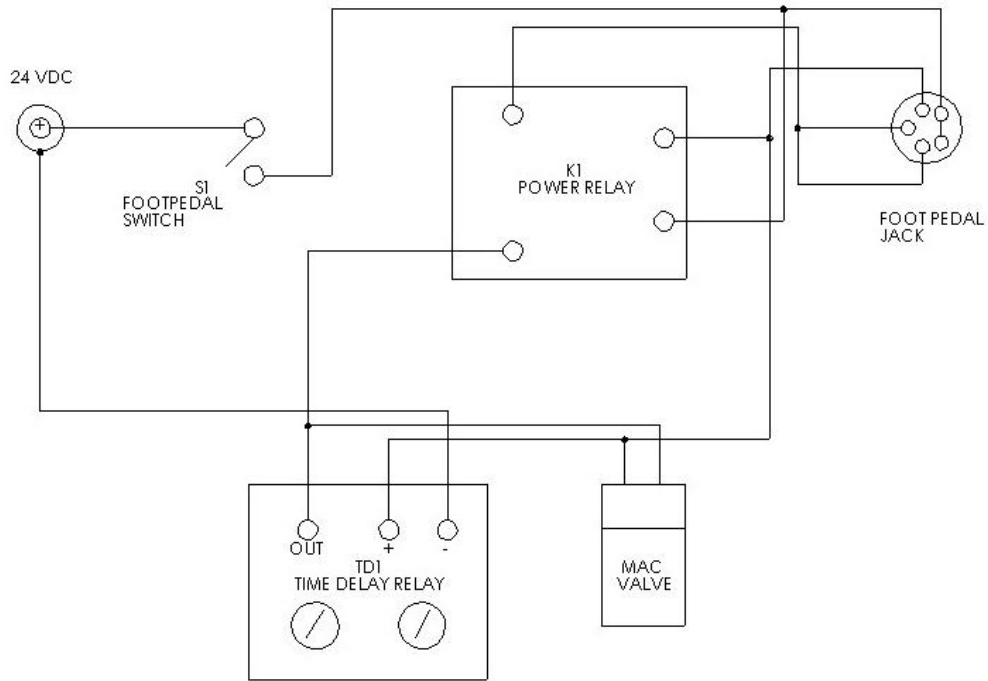

WIRING DIAGRAM
CRD 201 TD EXPANDER

9.0 Warranty

9.1 Warranty

The manufacturer warrants the product manufactured by it, when properly installed, operated, applied and maintained in accordance with the procedures and recommendations outlined in the manufacturer's operation manual, to be free from defects in material or workmanship for a period as specified below, provided such defect is discovered and brought to the manufacturer's attention within the aforesaid warranty period.

The manufacturer will repair or replace any product or part determined to be defective by the manufacturer within the warranty period, provided such defect occurred in the normal service and not as a result of misuse, abuse, neglect or accident. Normal maintenance items requiring routine replacement are not warranted. The warranty covers parts and labor for the warranty period unless otherwise specified. Repair or replacement shall be made at the factory or the installation site, at the sole discretion of the manufacturer. Any service performed on the product by anyone other than the manufacturer must first be authorized by the manufacturer.

Unauthorized service voids the warranty and any resulting charge or subsequent claim will not be paid. Products repaired or replaced under warranty shall be warranted for the unexpired portion of the warranty applying to the original product.

The foregoing is the exclusive remedy of any buyer of the manufacturer's product. The maximum damages liability of the manufacturer is the original purchase price of the product or part.

THE FORGOING WARRANTY IS EXCLUSIVE AND IN LIEU OF ALL OTHER WARRANTIES, WHETHER WRITTEN, ORAL, OR STATUTORY, AND IS EXPRESSLY IN LIEU OF THE IMPLIED WARRANTY OF MERCHANTABILITY AND THE IMPLIED WARRANTY OF FITNESS FOR A PARTICULAR PURPOSE. THE MANUFACTURER SHALL NOT BE LIABLE FOR LOSS OR DAMAGE BY REASON OF STRICT LIABILITY IN TORT OR ITS NEGLIGENCE IN WHATEVER MANNER INCLUDING DESIGN, MANUFACTURE OR INSPECTION OR THE EQUIPMENT OR ITS FAILURE TO DISCOVER, REPORT, REPAIR, OR MODIFY LATENT DEFECTS INHERENT THEREIN.

THE MANUFACTURER, HIS REPRESENTATIVE OR DISTRIBUTOR SHALL NOT BE LIABLE FOR LOSS OF USE OF THE PRODUCT OR OTHER INCIDENTAL OR CONSEQUENTIAL COSTS, EXPENSES, OR DAMAGES INCURRED BY THE BUYER, WHETHER ARISING FROM BREACH OF WARRANTY, NEGLIGENCE OR STRICT LIABILITY IN TORT.

The manufacturer does not warrant any product, part, material, component, or accessory manufactured by others and sold or supplied in connection with the sale of manufacturer's products.

9.2 Warranty Period

Parts and labor for ninety (90) days from the date of shipment from the factory. Freight to the factory on units that the manufacturer requests to be returned shall be paid by the purchaser, all return freight to be paid by the manufacturer; means of transportation to be specified by the manufacturer.

*For additional information contact: www.cleanroomdevices.com
Clean Room Devices, LLC
10855 Dover Street, Suite 100
Westminster, CO 80021
303-438-0843*