



**CLEAN ROOM DEVICES, LLC**

"WHERE TUBING AND FITTINGS COME TOGETHER"

# **CRD221 TIME DELAY TUBING EXPANDER**

**OPERATIONS MANUAL**

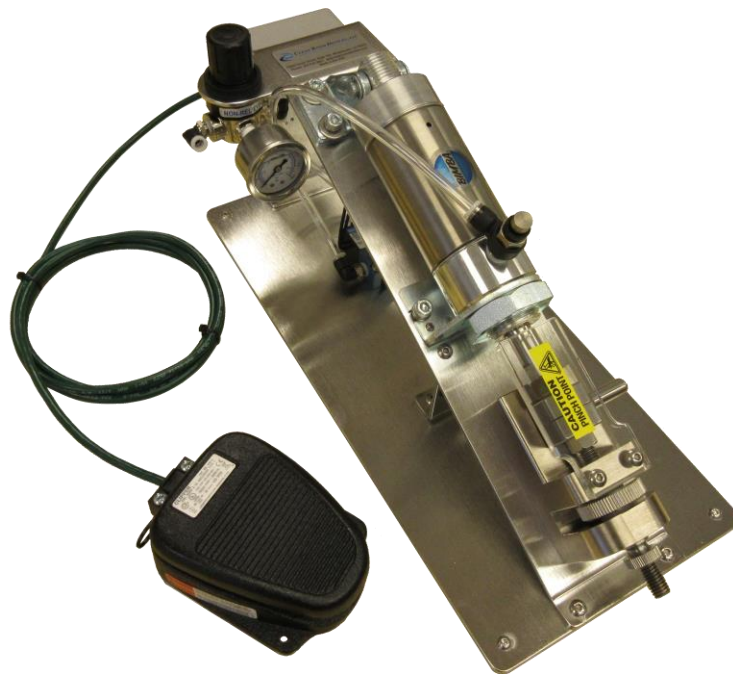

VERSION 1.1  
LAST EDITED 06.17.15  
*cleanroomdevices.com*

# Table of Contents

- Table of Contents.....2
- 1.0 General Product & Safety Information.....3
  - 1.1 Product Information
  - 1.2 Safety Information
- 2.0 Installation.....3
  - 2.1 Air Supply
  - 2.2 Electrical
- 3.0 Operation.....5
  - 3.1 Setting Time Delays
  - 3.2 Tube Expanding
  - 3.3 Jaw Installation and Removal
- 4.0 Troubleshooting.....10
- 5.0 Maintenance.....11
  - 5.1 Periodic Cleaning (annually)
- 6.0 Product Specifications.....11
- 7.0 Durometer Scale.....11
- 8.0 Wiring Schematic.....12
- 9.0 Warranty.....13
  - 9.1 Warranty
  - 9.2 Warranty period

## 1.0 General Product & Safety Information

### 1.1 Product Information

- Unit is designed to expand flexible tubing up to a durometer of Shore A 85 (Shore D 35), including any non-metallic braided materials
- The minimum/maximum inside tube diameter is 7/16" – 3/4"
- The standard expander jaws are tapered universal and are designed to meet most applications
- The unit design allows for simple operator adjustment

### 1.2 Safety Information

- This product uses an air cylinder and foot pedal to pneumatically actuate the expanding jaws. The unit is not intended to expand anything other than flexible tubing.

**WARNING**

**Avoid placing your fingers between the upper jaw block and the air cylinder mounting bracket while operating unit, sufficient pressure exists to cause personal injury.**

## 2.0 Installation

Ensure all five (5) rubber feet are completely stabilized on your work surface prior to applying air pressure to the unit.

### 2.1 Air Supply

- Connect a 1/4" air supply hose to the inlet on the pressure regulator. The air supply should be free of moisture and contaminants and provide a minimum of 100 psi.
- The regulator on the unit should be set to 80-120 psi.

### 2.2 Electrical

- 120 to 240V AC power supply required for operation. The unit will come with the appropriate power supply.

### 2.3 Connection setup

- Setting up the connections on the CRD221 is a simple task. Refer to *Figure 3.3.1* below when making all connections to the back panel.

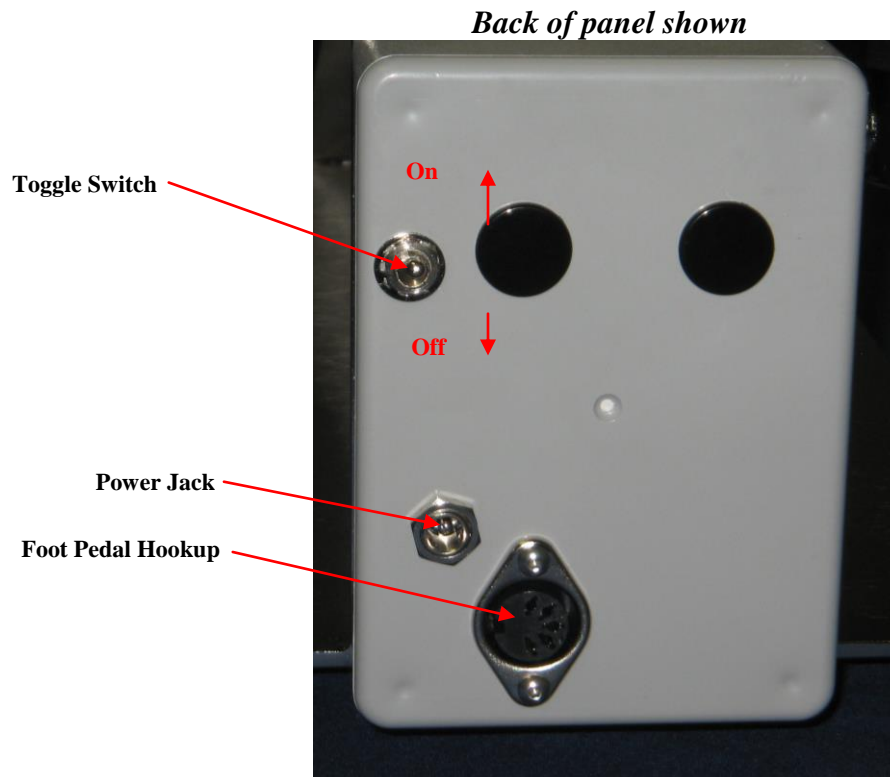

*Figure 3.3.1*

## 3.0 Operation

### 3.1 Setting the Time Delays

- The CRD221 expansion operation is designed to let the operator expand each piece of tubing twice. After the first expansion, the jaws will close and the operator rotates the tube 90 degrees and the jaws will automatically expand again using the sensor. This ensures that the tubing is expanded in a uniform fashion, and not deformed in only one direction. To assist with this 2-step expansion operation, there are 2 time delay relays on the unit.
  - **Expansion Time** – This setting adjusts the rate (0.5-25.0 seconds) at which the tube expansion occurs. The rate at which the tube is expanded is critical to prevent tearing. Some stiffer tubing might need a longer expansion time, while softer tubing can be expanded rapidly.
  - **Interval Time** – This setting adjusts the time delay rate (0.5-5.0 seconds) at which the jaws will cycle. It is adjusted to allow the operator to rotate the tubing 90 degrees at a comfortable pace between expanding.
- Remove the hole plugs with a screwdriver on the rear cover to gain access to the Time Delay adjustment pots. *Figure 3.4.1*



*Figure 3.4.1*

- Using a small Phillips drive screwdriver adjust the Time Delay relays. *Figure 3.4.2*



*Figure 3.4.2*

- *Figure 3.4.3* below shows the CRD221 with the rear cover removed, as well as the location of both time delay adjustments on the time delay relay:

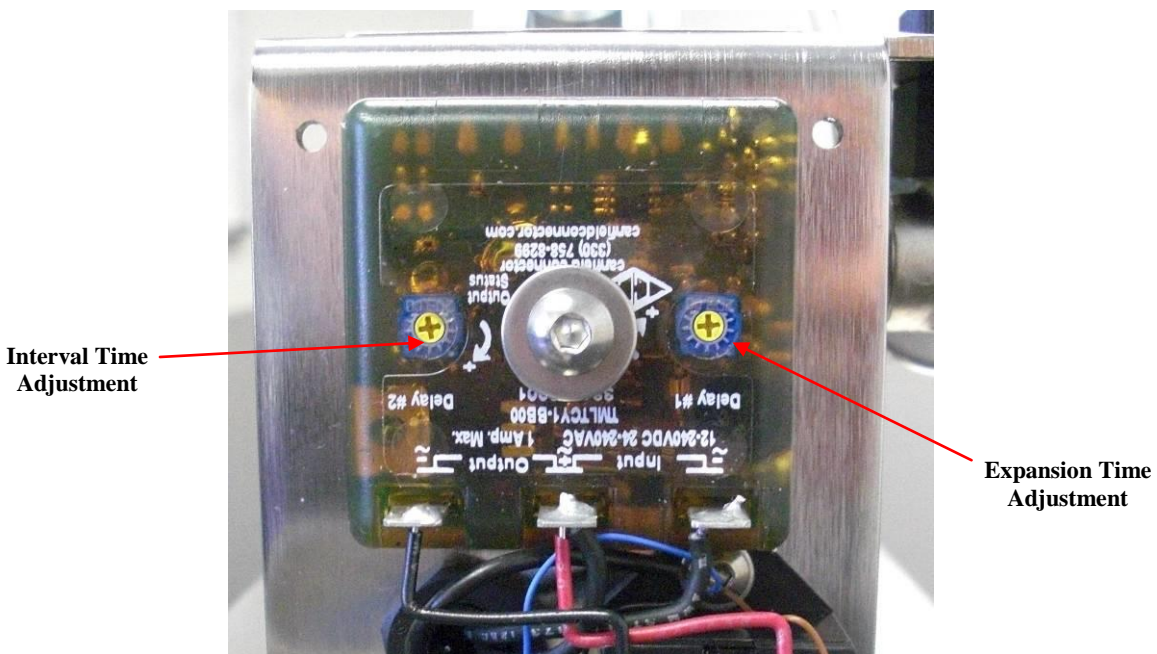

*Figure 3.4.3*

### 3.2 Tube Expanding

- To adjust the jaws for the size tubing to be expanded you need to loosen the ***Knurled Lock Nut***.
- With A/C power and compressed air attached to the expander, actuate the electric foot switch which will activate the expander. Adjust the expander lower jaw to the position you want using the ***Thumb Wheel Knob***.
- Turning the ***Thumb Wheel*** clockwise will increase the jaw expansion size, counter clockwise will decrease the jaw expansion size. This adjustment may require fine tuning depending on your tubing I.D., O.D., durometer and/or material.
- Once you have the expansion size you want tighten the ***Lock Nut*** to secure the adjustment.
- Place the tube over the ends of both expander jaws and hold firmly in place.
- Actuate the Tube Expander by pressing the electric foot switch.
- Rotate the tubing 90 degrees on the jaws and actuate the Tube Expander by pressing the electric foot switch again.

**Note: Several expanding actions may be necessary to effectively expand the end of the tube for the fitting/connector to slide in. Each time you expand the tubing remember to rotate the tubing 90 degrees on the jaws.**

- Quickly insert the component or tube connector before the tubing regains its original size.

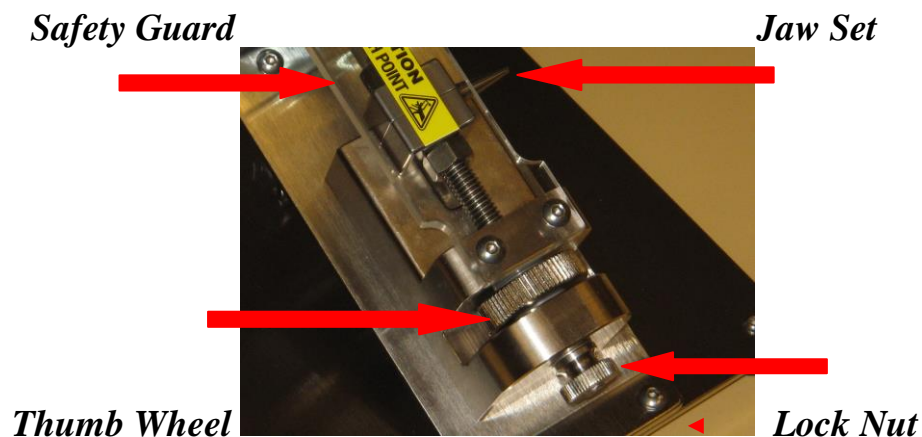



### 3.3 Jaw installation and removal

- Tools required are 9/16 open wrench, 3/4 open wrench and a 3mm and 3/32nd hex wrench
- Remove jaw guard by removing two 5x10mm screws using a 3mm hex wrench.
- Turn the thumb wheel clockwise until the cylinder shaft is fully extended in the jaw block channel. *Figure 3.3.1*

*Cylinder shaft shown fully extended in jaw block channel*

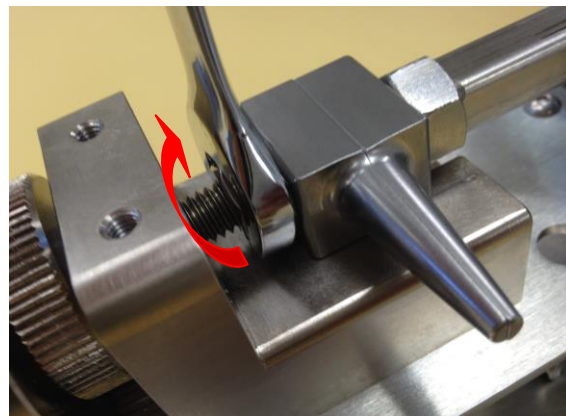

*Figure 3.3.1*

- Using a 3/4 open end wrench break the upper jaw nut loose. *Figure 3.3.2*
- Using a 9/16 open end wrench break the lower jaw nut loose. *Figure 3.3.3*



*Figure 3.3.2*

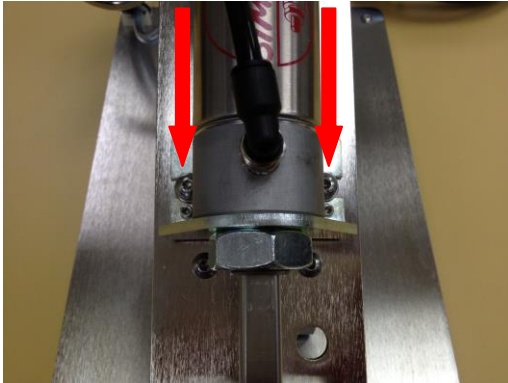

*Figure 3.3.3*



- Now remove the two 6x12mm screws holding the front cylinder mount bracket using a 3mm hex wrench. **Figure 3.3.4**. Rotate the cylinder backwards until it stops in the semi-vertical position. **Figure 3.3.5**

*Remove two 6x12mm screws*



**Figure 3.3.4**

*Cylinder semi-vertical position*



**Figure 3.3.5**

- Rotate the upper jaw by hand counter clockwise until removed.
- **Important note: when screwing upper jaw onto cylinder shaft it is important to only screw the jaw 1/2 to 2/3 of the way on. Any farther and the jaw may slip off the jaw block when the cylinder is retracted.**
- Remove the **Knurled lock nut** and grab threaded rod by hand and rotate rod counter clockwise while holding the lower expander jaw until the jaw is removed. **Figure 3.3.6**



**Figure 3.3.6**

- Select replacement jaw set and assemble them in the reverse order of operations.
- **Note: If the cylinder shaft won't retract when being cycled the adjustment of both set screws on the front cylinder mount bracket will need to be adjusted. To make the adjustment you must first loosen the two 6x12mm screws using a 3mm hex wrench (**Figure 3.3.7**) and then by adjusting the two set screws using a 3/32<sup>nd</sup> hex wrench. **Figure 3.3.8**. Now tighten the two 6x12mm screws and ensure jaw alignment.**



*Figure 3.3.7*



*Figure 3.3.8*

## 4.0 Troubleshooting

Operating Error	Action
Unit does not operate.	<ol style="list-style-type: none"> <li>1. Check the facility air connection.</li> <li>2. Check all air hose connections on the unit.</li> </ol>
Jaws do not expand.	<ol style="list-style-type: none"> <li>1. Ensure there are no obstructions keeping the jaws from expanding.</li> <li>2. Completely depress the foot pedal to actuate.</li> <li>3. Ensure the toggle switch is set to the on setting.</li> </ol>
Flexible tubing is splitting/tearing.	<ol style="list-style-type: none"> <li>1. Ensure the tubing being expanded does not exceed the recommended durometer.</li> <li>2. Ensure the lower jaw has been adjusted correctly for the tubing inside diameter (I.D.).</li> <li>3. Verify facility air supply psi or unit pressure adjustment.</li> <li>4. Increase the expansion time setting for a more gradual expansion.</li> </ol>

## 5.0 Maintenance

### 5.1 Periodic Cleaning (annually)

- Wipe down outer surfaces with alcohol, sepihol or mild detergents as required.

## 6.0 Product Specifications

Unit Weight	13.5 LBS / 6.1 KG
Overall Dimensions	15-1/4"l x 7"w x 7-1/2"h
Minimum Facility Air Supply	100 PSI
Unit Air Regulator Setting	80-120 PSI

## 7.0 Durometer Scale

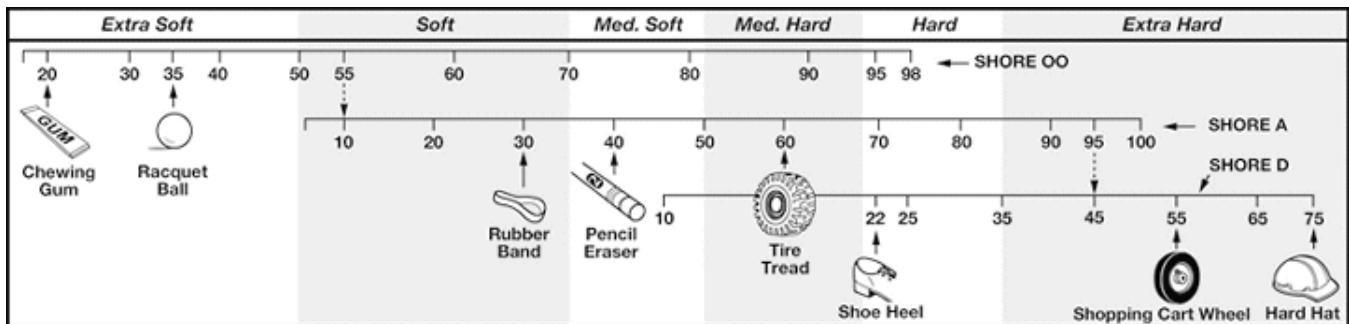

# 8.0 Wiring Schematic

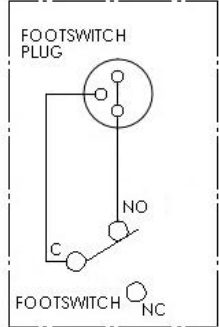
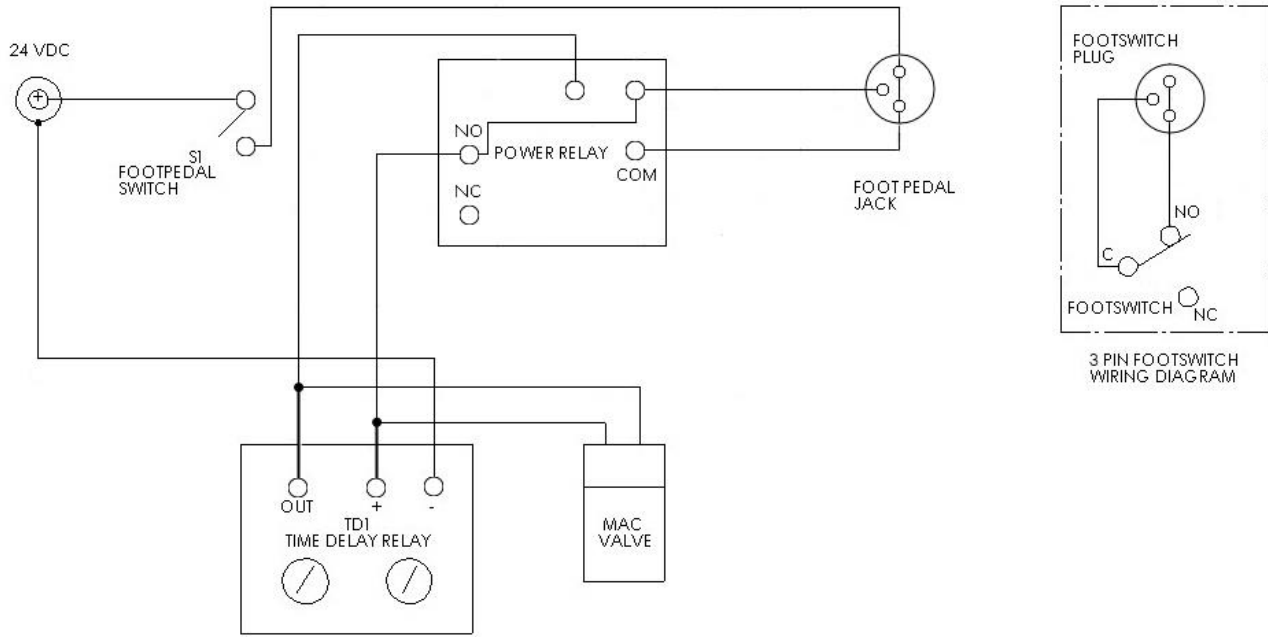

3 PIN FOOTSWITCH WIRING DIAGRAM

WIRING DIAGRAM  
CRD 221 TD EXPANDER

## 8.0 Warranty

### 8.1 Warranty

The manufacturer warrants the product manufactured by it, when properly installed, operated, applied and maintained in accordance with the procedures and recommendations outlined in the manufacturer's operation manual, to be free from defects in material or workmanship for a period as specified below, provided such defect is discovered and brought to the manufacturer's attention within the aforesaid warranty period.

The manufacturer will repair or replace any product or part determined to be defective by the manufacturer within the warranty period, provided such defect occurred in the normal service and not as a result of misuse, abuse, neglect or accident. Normal maintenance items requiring routine replacement are not warranted. The warranty covers parts and labor for the warranty period unless otherwise specified. Repair or replacement shall be made at the factory or the installation site, at the sole discretion of the manufacturer. Any service performed on the product by anyone other than the manufacturer must first be authorized by the manufacturer.

Unauthorized service voids the warranty and any resulting charge or subsequent claim will not be paid. Products repaired for replaced under warranty shall be warranted for the unexpired portion of the warranty applying to the original product.

The foregoing is the exclusive remedy of any buyer of the manufacturer's product. The maximum damages liability of the manufacturer is the original purchase price of the product or part.

THE FORGOING WARRANTY IS EXCLUSIVE AND IN LIEU OF ALL OTHER WARRANTIES, WHETHER WRITTEN, ORAL, OR STATUTORY, AND IS EXPRESSLY IN LIEU OF THE IMPLIED WARRANTY OF MERCHANTABILITY AND THE IMPLIED WARRANTY OF FITNESS FOR A PARTICULAR PURPOSE. THE MANUFACTURER SHALL NOT BE LIABLE FOR LOSS OR DAMAGE BY REASON OF STRICT LIABILITY IN TORT OR ITS NEGLIGENCE IN WHATEVER MANNER INCLUDING DESIGN, MANUFACTURE OR INSPECTION OR THE EQUIPMENT OR ITS FAILURE TO DISCOVER, REPORT, REPAIR, OR MODIFY LATENT DEFECTS INHERENT THEREIN.

THE MANUFACTURER, HIS REPRESENTATIVE OR DISTRIBUTOR SHALL NOT BE LIABLE FOR LOSS OF USE OF THE PRODUCT OR OTHER INCIDENTAL OR CONSEQUENTIAL COSTS, EXPENSES, OR DAMAGES INCURRED BY THE BUYER, WHETHER ARISING FROM BREACH OF WARRANTY, NEGLIGENCE OR STRICT LIABILITY IN TORT.

The manufacturer does not warrant any product, part, material, component, or accessory manufactured by others and sold or supplied in connection with the sale or manufacturer's products.

### 8.2 Warranty Period

Parts and labor for ninety (90) days from the date of shipment from the factory. Freight to the factory on units that the manufacturer requests to be returned shall be paid by the purchaser, all return freight to be paid by the manufacturer; means of transportation to be specified by the manufacturer.

*For additional information contact: [www.cleanroomdevices.com](http://www.cleanroomdevices.com)  
Clean Room Devices, LLC  
10855 Dover Street, Suite 100  
Westminster, CO 80021  
303-438-0843*